

# IN-LINE RECTANGULAR DUCT FANS

## IRB ECOWATT Series

Range of low-profile rectangular duct fans with high-quality features, specially designed for rectangular ducts, manufactured from galvanized steel, cover for inspection and cleaning, remote terminal box, IP55, centrifugal fan with backward curved impeller, dynamically balanced.

### Motors

EC Brushless motor of high-efficiency and low-consumption, supply power 230V $\pm$ 15% - 50/60Hz, IP44, ball bearings and thermal protection. Speed 100% controllable by potentiometer located in the terminal box or via external control like REB-ECOWATT. Analogue input to control the fan via external signal 0-10V.



ectechnology



PART L2: 2013  
COMPLIANT



At 50% of full speed fan power consumption is reduced by 70%

ENERGY EFFICIENT



VENTILATION SYSTEM

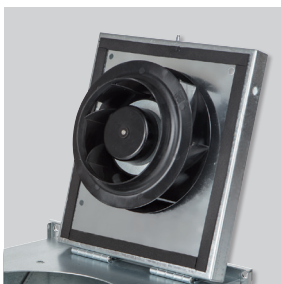

**Inspection door**  
Inspection door that facilitates maintenance.



**Versatile design**  
Can be installed in any position.



**Backward impeller**  
To prevent accumulation of dirtiness. Dynamically balanced.  
Plastic impeller for sizes 180 and 200, aluminium for 225 and 315A.



**Insulated IP55 remote terminal box**  
To ease installation and maintenance.

# In-Line rectangular duct fans IRB ECOWATT

## TECHNICAL CHARACTERISTICS

Before making any electrical connection ensure that the voltage and frequency of the mains electrical supply matches that of the fan data plate label.

Model	Nominal ducting diameter (mm)	Input signal voltage (V)	Speed (rpm)	Maximum absorbed power (W)	Maximum absorbed current (A)	Maximum airflow (m³/h)	Sound pressure level* (dB(A))			Weight (kg)
							Outlet	Inlet	Radiated	
<b>SINGLE PHASE</b>										
IRB-180 ECOWATT	300x150	10	3000	75	0,5	640	56	56	41	10
		8	2740	58	0,4	590	54	53	38	
		6	2170	30	0,2	460	47	50	32	
		4	1600	14	0,1	330	43	41	26	
IRB-200 ECOWATT	400x200	10	2650	207	1,4	1.400	63	60	47	17
		8	2370	149	1,0	1.250	60	58	44	
		6	1890	80	0,6	990	55	52	39	
		4	1410	38	0,3	720	48	45	35	
IRB-225 ECOWATT	500x250	10	2320	345	1,5	2.140	69	65	51	22
		8	2100	261	1,1	1.940	66	63	50	
		6	1710	149	0,7	1.590	60	57	47	
		4	1320	76	0,4	1.230	54	51	44	
IRB-315A ECOWATT	600x350	10	1500	298	1,3	2.890	63	59	47	39
		8	1400	244	1,0	2.690	61	58	46	
		6	1180	154	0,7	2.280	57	54	43	
		4	950	88	0,4	1.840	51	48	39	

\* Sound pressure level measured in free field condition at 3m, at the medium working point on the performance curve

## DIMENSIONS (mm)

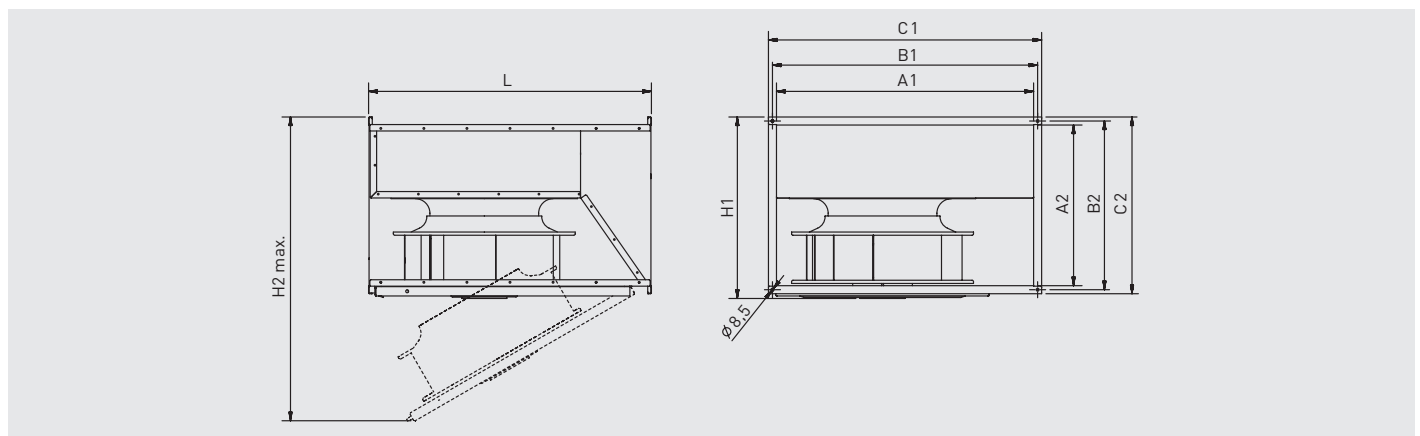

Model	A1	A2	B1	B2	C1	C2	H1	H2 max.	L
180	300	150	320	170	340	190	205	480	375
200	400	200	420	220	440	240	255	650	500
225	500	250	520	270	540	290	305	730	530
315	600	350	620	370	640	390	405	1020	720

## PERFORMANCE CURVES

- $q_v$ : Airflow in  $m^3/h$ .
- $p_{sf}$ : Static pressure in Pa.
- SFP: specific fan power in  $W/m^3/h$  (blue curves).
- P: Input power in W.
- Performance data in accordance with ISO 5801 and AMCA 210-99.

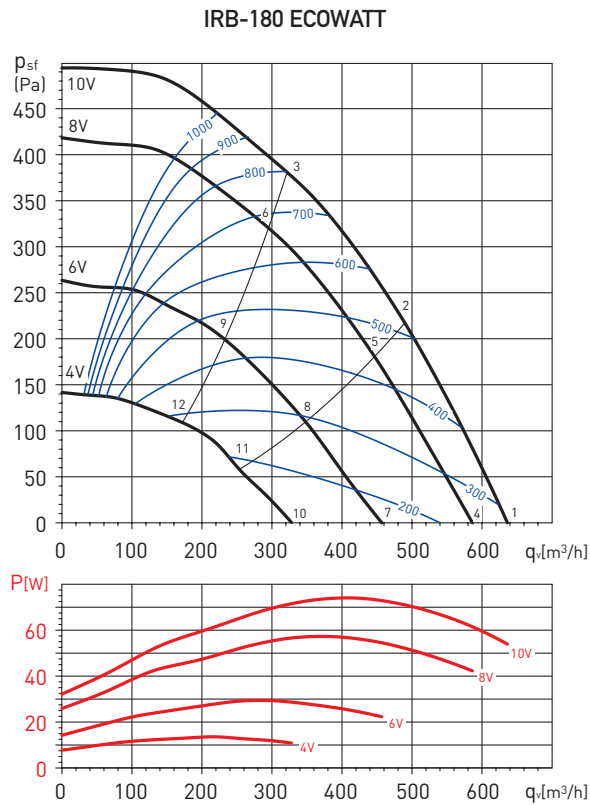

## Sound power level spectrums in dB(A)

Working point		63	125	250	500	1.000	2.000	4.000	8.000	LwA
1	Inlet	35	48	72	71	69	70	66	59	77
	Outlet	35	44	69	70	73	74	70	63	79
	Radiated	27	39	58	57	52	53	49	43	62
2	Inlet	32	43	70	68	67	67	64	54	75
	Outlet	31	40	65	67	70	70	67	55	75
	Radiated	24	34	56	54	50	50	48	38	60
3	Inlet	33	41	64	63	65	65	61	49	71
	Outlet	32	40	62	65	68	68	64	51	73
	Radiated	24	32	50	49	48	48	44	33	55
4	Inlet	34	46	71	63	68	69	65	57	75
	Outlet	34	42	67	67	71	72	68	60	77
	Radiated	27	37	57	50	50	52	48	42	60
5	Inlet	31	41	68	60	65	65	63	50	72
	Outlet	30	38	64	64	68	69	66	52	73
	Radiated	23	32	54	47	48	48	46	34	57
6	Inlet	31	39	62	58	63	63	59	46	68
	Outlet	31	38	61	62	65	66	61	48	71
	Radiated	23	30	48	45	46	46	42	30	53
7	Inlet	30	43	63	57	63	64	60	46	69
	Outlet	30	39	62	61	66	68	64	50	72
	Radiated	17	35	50	45	45	47	43	34	54
8	Inlet	27	38	60	55	60	61	56	41	66
	Outlet	27	36	60	59	62	65	59	44	69
	Radiated	14	30	47	43	43	45	39	29	51
9	Inlet	26	38	58	54	58	59	51	37	64
	Outlet	26	35	58	57	60	62	53	39	66
	Radiated	13	30	45	42	41	42	33	25	49
10	Inlet	26	40	52	52	56	59	51	34	62
	Outlet	27	37	53	54	59	63	53	38	65
	Radiated	18	29	42	39	40	42	36	31	47
11	Inlet	23	37	50	50	54	57	43	30	60
	Outlet	25	34	50	52	56	60	45	33	62
	Radiated	15	26	40	37	38	40	28	26	45
12	Inlet	23	38	47	49	52	52	38	28	57
	Outlet	24	32	46	50	53	54	40	29	58
	Radiated	15	28	37	36	36	35	23	24	42

# In-Line rectangular duct fans IRB ECOWATT

## PERFORMANCE CURVES

- $q_v$ : Airflow in  $m^3/h$ .
- $p_{sf}$ : Static pressure in Pa.
- SFP: specific fan power in  $W/m^3/h$  (blue curves).
- P: Input power in W.
- Performance data in accordance with ISO 5801 and AMCA 210-99.

IRB-200 ECOWATT

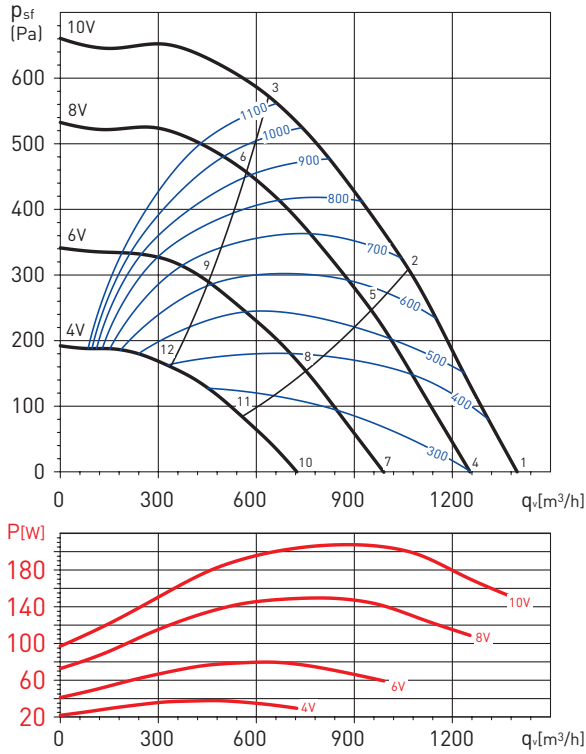

Sound power level spectrums in dB(A)

Working point		63	125	250	500	1.000	2.000	4.000	8.000	LwA
1	Inlet	45	59	79	72	78	74	69	66	83
	Outlet	45	62	75	79	82	83	75	71	87
	Radiated	45	50	64	62	61	61	58	55	69
2	Inlet	40	55	76	68	74	70	67	62	79
	Outlet	41	55	72	73	76	77	71	67	82
	Radiated	40	46	61	58	57	58	55	51	65
3	Inlet	36	51	72	65	72	67	64	59	76
	Outlet	40	54	67	71	74	74	67	62	79
	Radiated	37	41	57	55	55	55	53	47	63
4	Inlet	43	58	78	68	75	71	67	63	81
	Outlet	42	59	73	75	78	79	72	67	83
	Radiated	43	50	63	58	57	57	55	53	66
5	Inlet	38	53	75	65	71	67	64	59	77
	Outlet	39	54	68	71	74	75	69	63	79
	Radiated	39	46	60	55	54	54	52	49	63
6	Inlet	33	50	69	62	69	65	62	55	74
	Outlet	37	53	65	69	71	71	64	58	76
	Radiated	34	42	55	52	51	51	50	45	59
7	Inlet	39	54	71	62	69	65	61	57	75
	Outlet	38	56	68	69	72	73	66	60	78
	Radiated	39	48	58	53	51	51	49	47	61
8	Inlet	34	50	68	59	66	62	59	50	71
	Outlet	34	51	65	66	68	69	64	54	74
	Radiated	34	44	55	50	48	48	46	40	58
9	Inlet	30	48	63	58	64	59	56	47	68
	Outlet	32	52	62	63	65	65	58	49	71
	Radiated	30	42	50	48	46	45	43	36	54
10	Inlet	34	59	59	55	63	59	56	42	67
	Outlet	33	60	58	62	65	66	60	46	70
	Radiated	34	54	46	46	45	45	44	33	56
11	Inlet	29	57	57	53	60	56	54	39	64
	Outlet	29	57	55	58	61	62	56	42	67
	Radiated	30	52	43	44	42	42	42	30	54
12	Inlet	26	51	55	52	57	52	48	36	61
	Outlet	27	51	52	55	58	58	50	38	63
	Radiated	26	47	41	43	39	39	36	27	50

## PERFORMANCE CURVES

- $q_v$ : Airflow in  $m^3/h$ .
- $p_{sf}$ : Static pressure in Pa.
- SFP: specific fan power in  $W/m^3/h$  (blue curves).
- P: Input power in W.
- Performance data in accordance with ISO 5801 and AMCA 210-99.

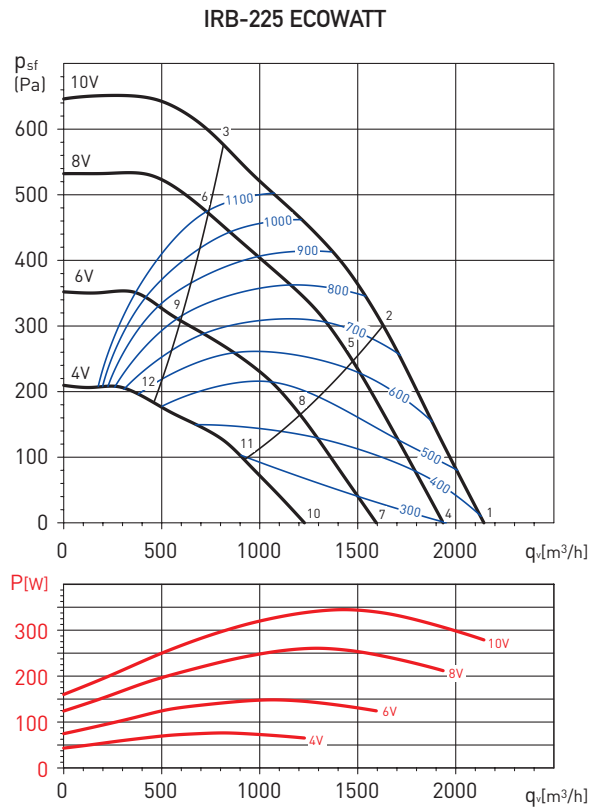

## Sound power level spectrums in dB(A)

Working point		63	125	250	500	1.000	2.000	4.000	8.000	LwA
1	Inlet	53	69	80	84	82	78	70	64	88
	Outlet	55	71	81	85	87	86	77	70	91
	Radiated	54	60	70	67	67	63	60	55	74
2	Inlet	49	65	77	80	78	74	66	60	84
	Outlet	51	69	78	81	83	82	73	66	88
	Radiated	49	57	67	63	63	59	56	51	70
3	Inlet	47	63	73	74	72	68	60	53	79
	Outlet	50	68	74	75	77	75	67	60	82
	Radiated	48	54	63	57	57	53	50	44	66
4	Inlet	51	67	79	81	79	75	67	62	85
	Outlet	53	70	79	82	84	82	74	67	89
	Radiated	52	58	69	65	65	61	58	54	72
5	Inlet	47	64	76	77	76	71	63	58	82
	Outlet	48	68	76	78	80	79	70	64	85
	Radiated	47	55	67	61	61	57	54	50	69
6	Inlet	47	62	72	71	70	65	57	50	76
	Outlet	50	66	71	73	74	72	64	57	79
	Radiated	47	53	63	55	55	50	48	42	65
7	Inlet	46	64	73	75	74	69	62	59	79
	Outlet	48	68	74	77	78	77	68	64	83
	Radiated	46	56	63	64	64	58	52	51	69
8	Inlet	42	61	70	71	70	65	58	54	76
	Outlet	44	65	71	73	74	73	64	59	79
	Radiated	42	53	61	60	60	54	48	46	66
9	Inlet	42	59	65	66	64	60	52	43	71
	Outlet	44	66	65	67	69	67	59	49	74
	Radiated	42	51	56	54	55	48	43	36	61
10	Inlet	41	62	66	68	66	62	55	55	73
	Outlet	42	69	67	70	71	69	61	60	77
	Radiated	43	55	56	64	54	52	46	49	66
11	Inlet	38	61	63	66	63	58	52	49	70
	Outlet	40	67	63	67	67	66	58	53	73
	Radiated	40	54	54	61	51	48	43	43	63
12	Inlet	37	55	58	61	57	53	44	34	65
	Outlet	38	59	57	62	62	60	51	39	67
	Radiated	38	48	48	56	45	43	35	27	58

# In-Line rectangular duct fans IRB ECOWATT

## PERFORMANCE CURVES

- $q_v$ : Airflow in  $m^3/h$ .
- $p_{sf}$ : Static pressure in Pa.
- SFP: specific fan power in  $W/m^3/h$  (blue curves).
- P: Input power in W.
- Performance data in accordance with ISO 5801 and AMCA 210-99.

IRB-315A ECOWATT

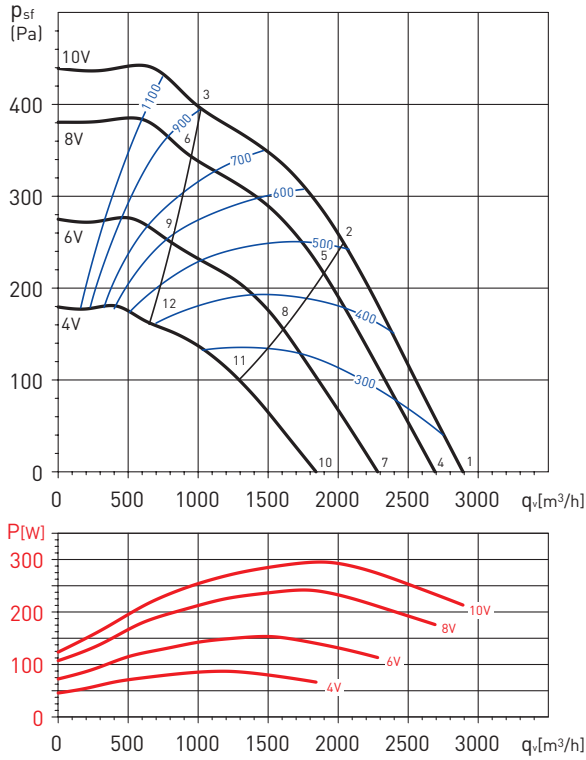

Sound power level spectrums in dB(A)

Working point		63	125	250	500	1.000	2.000	4.000	8.000	LwA
1	Inlet	49	73	74	76	73	70	67	64	81
	Outlet	48	71	76	80	82	77	72	64	86
	Radiated	44	64	65	60	57	55	51	48	69
2	Inlet	48	70	72	72	69	67	63	54	78
	Outlet	50	67	73	76	78	73	67	58	82
	Radiated	43	60	62	56	54	52	47	38	66
3	Inlet	50	68	68	68	65	63	58	48	74
	Outlet	50	67	70	72	73	69	62	53	78
	Radiated	45	58	58	51	50	48	41	32	62
4	Inlet	47	77	71	74	71	68	66	61	80
	Outlet	46	71	74	78	80	75	70	61	84
	Radiated	42	64	61	57	56	54	50	45	67
5	Inlet	47	74	70	70	67	65	61	51	77
	Outlet	48	67	72	74	76	71	65	56	80
	Radiated	41	62	60	54	52	51	45	35	65
6	Inlet	49	66	66	66	64	61	56	46	72
	Outlet	49	66	68	70	71	67	60	51	76
	Radiated	44	54	56	49	48	47	39	30	60
7	Inlet	45	74	68	70	66	64	63	50	77
	Outlet	43	67	70	73	75	70	66	54	79
	Radiated	40	64	57	54	54	52	47	35	66
8	Inlet	43	69	66	66	63	61	56	45	73
	Outlet	45	66	68	70	71	67	60	51	76
	Radiated	38	59	56	50	50	49	40	31	62
9	Inlet	46	63	63	62	60	57	50	40	69
	Outlet	45	63	63	65	67	63	54	45	72
	Radiated	41	53	53	46	47	46	34	25	57
10	Inlet	42	65	64	64	61	60	57	42	71
	Outlet	42	67	65	68	69	66	60	47	74
	Radiated	38	54	53	54	56	46	43	32	61
11	Inlet	40	61	62	61	58	56	49	38	67
	Outlet	42	63	62	64	65	61	52	41	70
	Radiated	36	50	51	51	54	42	35	27	58
12	Inlet	45	57	59	57	58	52	44	34	64
	Outlet	44	56	58	60	62	57	47	36	66
	Radiated	41	46	48	47	53	38	29	23	56

## MOUNTING ACCESSORIES



**IFL G4**  
Filtration box with IFR-G4 filters incorporated



**IFL-F**  
Filtration box to install IFR-F filters.  
**IFR-F**  
Filters to install IFL-F filtration box



**IBE**  
Electric heater



**IBW**  
Hot water coil



**IBR**  
Flanges



**IAE**  
Rectangular flexible connector.



**DEF**  
Rectangular protection guard



**ISA**  
Anti-vibration mounting  
(1 ISA = 4 supports)



**IAA**  
Sound attenuators



**IJK**  
Motorised damper. As accessory: actuator LM230A.

## ELECTRICAL ACESORIES



**CONTROL ECOWATT AC/4A**  
Control element for DCV (Demand Controlled Ventilation).



**REB-ECOWATT**  
Speed controller.



**DPS 2-30**  
**DPS 10-100**  
Differential pressure switches:  
- DPS 2-30: from 20Pa to 300Pa.  
- DPS 10-100: from 100Pa to 1000Pa.



**LM-230A**  
Electrical damper actuator.



**TTC-2000**  
**TTC-2000 + TTS-1**  
**TTC-40F + TTS-4**  
Three phase electric heater controller.



**TG-K330**  
Duct temperature sensor.  
**TG-R530**  
Room temperature sensor.



**SC02-A**  
CO<sub>2</sub> and temperature sensor.  
**SC02-AD**  
CO<sub>2</sub> and temperature sensor with display.  
**SCHAT-AD**  
CO<sub>2</sub> sensor, temperature and relative humidity with display.  
**SC02-AR**  
CO<sub>2</sub> sensor, temperature. Relay output.



**CPFL-S / CPFL-E**  
Presence detector.



**TDP-S / TDP-D**  
Pressure sensor.

## IRB ECOWATT IN LINE CENTRIFUGAL DUCT FAN PRICES

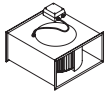

Code	Model	Trade Price	Electric Heater Battery	Trade Price	Heater Battery Controller	Trade Price	Duct Temp. Sensor	Trade Price	Room Temp. Sensor	Trade Price
513293400	IRB-180 ECOWATT	£389.00								
513293500	IRB-200 ECOWATT	£457.00	IBE-200/9T	£583.06	TTC-2000 (REG 16)	£787.21	TG-K330	£98.27	TG-R530	£39.10
513293600	IRB-225 ECOWATT	£657.00	IBE-225/16.5T	£779.18	TTC-2000 (REG 16)	£787.21	TG-K330	£98.27	TG-R530	£39.10
513293700	IRB-315A ECOWATT	£727.00	IBE-315/30T	£1193.89	TTC-2000 (REG 16) + TTS-1 (RA)	£1180.45	TG-K330	£98.27	TG-R530	£39.10



Code	Model	Trade Price
5401304000	REB-ECOWATT 1-10V CONTROLLER	£62.22



### S&P UK VENTILATION SYSTEMS LTD

S&P House, Wentworth Road, Ransomes Europark  
Ipswich, Suffolk, IP3 9SW.

Tel: 08454 700 074

Fax: 08454 700 075

sales.uk@solerpalau.com

www.solerpalau.co.uk